

The Luftmeister[®] system

- ▶ Energy management in air-conditioning and process air systems
- ▶ Consumption-based charging of ventilation costs



All-in-one

- Meter
- Transmitter
- Datalogger

IS ENERGY MANAGEMENT AND METERING A TOPIC FOR AIR-CONDITIONING AND PROCESS AIR SYSTEMS?

Recording media consumption data is not a new topic – it has been one of the key elements used in the calculation of operating costs fairly for many decades. It also plays a vital role when implementing energy management policies that encourage consumers to save resources. Over the years, companies have especially focused on their usage of electricity, heating, cooling and occasionally compressed air. Accurately measuring the energy flow in air ducts and recording consumption data has in the past been virtually impossible or just not economically viable. Though now Luftmeister® offers a solution.



INDUSTRY

An ever growing number of large and medium-sized industrial companies have been implementing energy management systems. Regardless of whether these are based on the leading energy management standard EN 50001 or approach the issue from the direction of environmental certification (EN 14001 / EMAS etc.): the central objective is the same: to reduce the consumption of materials and energy.

Three complementary motivating factors underpin this goal:

- The desire to reduce operating costs
- The desire to make a positive, sustainable contribution to protecting the environment
- Companies wish to retain subsidies

For years, energy management officers have been “harvesting the low hanging fruit” and achieving noteworthy savings through peak load management, co-generation of power and cooling and reduction of compressed air leakages. However, over the coming years they will have to prove that they are continuing to make substantial savings! For this reason there is now more focus on the cost-intensive areas of air-conditioning and process air systems. And this must be proven by reliable technical measurements – estimates that are not backed up by measurement data are increasingly considered inadequate to be compliant with EN ISO 50003.



COMMERCIAL BUILDINGS

Commercial buildings with multiple individual commercial tenants (office buildings, shopping centres etc.) face a challenge that continues to be the reason for many legal disputes: how to attribute building utility costs. Meters generally are the accepted way on which to base the costs of cooling, heating and electricity consumption.

However, no such meter has been available for air-conditioning systems until now. For many years, these costs have been divided based on the size of the area rented.

A bookshop that occupies 7 % of the area of a shopping centre will be charged 7 % of the annual ventilation costs. The first problem with this approach is that it provides no incentive to generate savings as the costs are not linked to consumption. In addition, using a formula which is based on the area is inaccurate because different premises have different air exchange rate requirements. The Luftmeister® system and the new VDI Guideline 2077 Sheet 4 redress this problem.

Luftmeister® is the first air consumption meter on the market. As well as opening the way to fair, consumption-based billing that improves sustainability and the attractiveness of the property, it can also help reverse the trend of tenants insisting on separate air-conditioning systems. Sharing a larger, centralised air-conditioning system (instead of a number of smaller units) generates considerable savings in terms of planning, installation and operating costs.

THE MEASUREMENT TECHNOLOGY: PRECISE FLOW MEASUREMENTS IN PRACTICAL APPLICATIONS

Systems that obtain precise and continuous flow measurements in air ducts are rarely found in practical applications. In fact, they are generally completely absent in older plants. During the development of Luftmeister® the focus was on practical applications:

- Long, straight inlet and outlet pipes are very rare. After sources of **upstream interference** such as double bends, it is more typical to have only a very **short straight length** before the measuring point.
- In order to accommodate the resulting asymmetric flow profiles and also cleanly record situations of **partial flow**, Luftmeister® uses an optimum combination of sensors and calibration.

TWO LUFTMEISTER® SERIES EACH FEATURING THREE MODELS

<p>MS Mass flow</p> <p>Precise flow measurements</p> <p>Optional: Filter monitoring or damper module (actual / target values for external flow regulation)</p> <p>m³/h kg/h m/s Pa_{abs}</p>	<p>Enthalpy probes and analogue sensor inputs (4..20mA)</p> <p>MS / LZ offer up to 4 inputs, EZ up to 5:</p> <ul style="list-style-type: none"> - Enthalpy probe EN55 - Temperature / humidity / absolute pressure - Differential pressure (addition input with filter monitoring module or external pressure sensor system)
<p>LZ Air meter</p> <p>Distribution of costs based on air</p> <p>Air supply monitoring</p> <p>m³ kg</p>	
<p>EZ Air energy meter</p> <p>Distribution of costs based on air and energy consumption, monitoring of hygiene</p> <p>Optimise operation of AC systems, increase energy efficiency</p> <p>Multi-channel logging for up to 9 measurement channels</p> <p>kW kWh kWh %rh °C</p>	

The Luftmeister range has to be functional in a wide variety of scenarios, therefore Luftmeister® developed three different models of the **Luftmeister® 55 and 57 series**. These are described in the table below. The **MS** model offers high precision mass (and volume flow) measurements. The **LZ** model adds an air meter function (air consumption in m³ or kg). The **EZ** model (air energy meter) also calculates air energy contributions, see also page 6.

55 SERIES (for conditioned air)	57 SERIES (for conditioned and process air)
	
	
Compact ready-to-install measurement section (\bigcirc : 0,6 m ⁴⁾ \square : 0,4 m ⁴⁾	Remote customised on-site installation
On-board measurement transmitter	Measurement transmitter installed at distance of up to 20 m
DN 100 .. 630 mm \bigcirc / \square (200x100 up to 1000x1000 mm)	DN 10 .. 4000 mm \bigcirc / \square
-20 .. 60 °C ¹⁾	-100 .. 800 °C ²⁾
"Doppelschwert" probes and redundant sensor system (Δ P)	Diverse range of primary elements (Δ P), with redundant Δ P sensors ²⁾
Factory calibration (accredited) optional	On-site calibration / adjustment
LZ / EZ: Optional legal-for-trade instrument	
Display (for legal-for-trade: obligatory)	
0, 5 or 10 impulse or switching outputs	
1, 6 or 11 analogue outputs	
M-bus (only for LZ / EZ), MODBUS-RTU	
Filter monitoring ³⁾ or damper module (actual / target values for external flow regulation)	

Options

¹⁾ for conditioned air: Enthalpy probe EN 55; for process air -40 .. 180 °C: Enthalpy probe EN 57, otherwise: analogue input for °C probe supplied by the customer

²⁾ We will be pleased to supply a suitable primary element for your measurement location, e.g. plastic, aluminium or stainless steel flow probes

³⁾ see page 5 section 4 and 6

⁴⁾ exact length depends on the diameter; please enquire

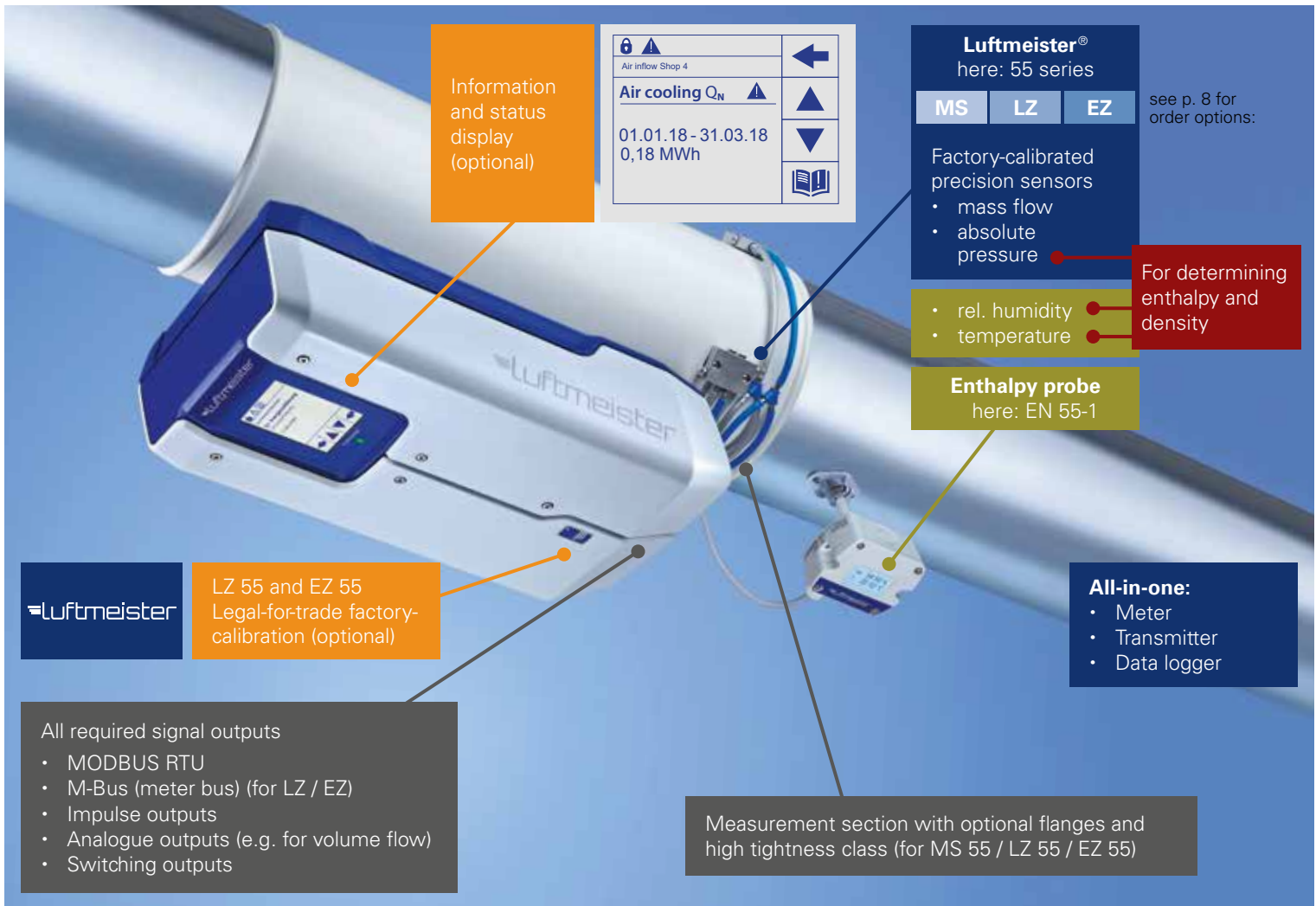

SIX USES – WHAT CAN LUFTMEISTER® DO FOR ME?

€ 1. CONSUMPTION-BASED ATTRIBUTION OF COSTS

LZ EZ see also p. 7

Luftmeister® allows to replace the current unfair billing system, which is based on the size of tenant's rented area, by a fair calculation of costs based on actual consumption. The operator has the choice of an **air quantity meter** (m³ or kg, model LZ) or additional and separate **air energy meters** for heating and cooling (in kWh heat / kWh cold, model EZ). These meters are ideal for use in applications according to the new German directive on billing ventilation costs (VDI 2077 Sheet 4) and are defined there as state-of-the-art.

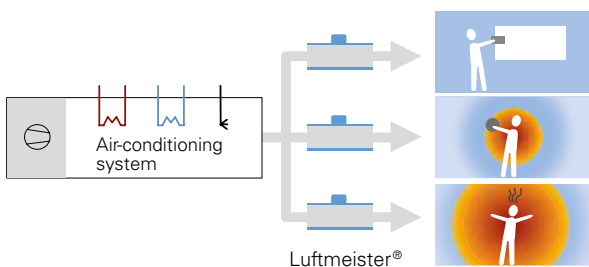

2. RUGGED MEASUREMENT SOLUTIONS ALSO AVAILABLE FOR PROCESS AIR

MS LZ EZ (Family 57)

Flow monitoring is often essential for industrial process air applications – from monitoring air extraction to transportation of media by air, frequently in dusty or high temperature environments.

At the same time, many operators are interested in the thermal performance or energy transfer of their systems, e.g. in the use of waste heat, regulation of heat exchangers or complex heating networks.

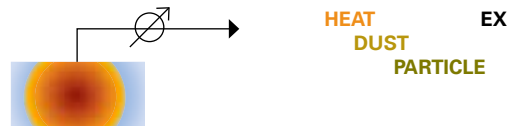



3. MULTI-CHANNEL LOGGING / AIR SUPPLY MONITORING

MS LZ EZ

Whether it is deployed centrally in an air-conditioning system or in a decentralised role in air inflow ducts: Luftmeister® continuously records flows (mass flow / volume flow) and absolute pressure with a high degree of accuracy. Its enthalpy probe also provides accurate data for the temperature and humidity of supply air to every zone.

Up to 9 logger channels are available for recording momentary values or meter data. This enables the operator to continuously monitor essential values for flow and air exchange. At the same time, it allows to identify potential savings, e.g. by switching off the system at night or reducing partial loads. This not only cuts waste but also eliminates the risk of undersupplying certain areas of the building with air. Operators and users can see whether the system is compliant with the terms of the air supply contract at any time. They can also implement measures to prevent waste and undersupply. The system also supports quick adaptation of air flows of parallel ducts.

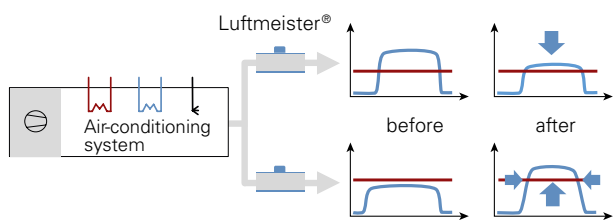

5. IDENTIFY ENERGY CONTRIBUTIONS, MONITOR EFFICIENCY

EZ see also p. 6

It is already possible to measure the input energies of an air-conditioning system (electricity, heating, cooling, etc.). But how are flows of thermal energy distributed through the ventilation system? Which waste heat quantities are actually provided? And last but not least: how do heat recovery systems perform in situations where there is only a partial load, at night or other non-peak-load situations.

Luftmeister helps to identify potential savings that could be achieved by adjusting controls or even making structural modifications. All relevant energy contributions right down to "A/C unit energy controlling" (analysis of the energetic contribution of each stage of conditioning within the air-conditioning system) are made transparent.

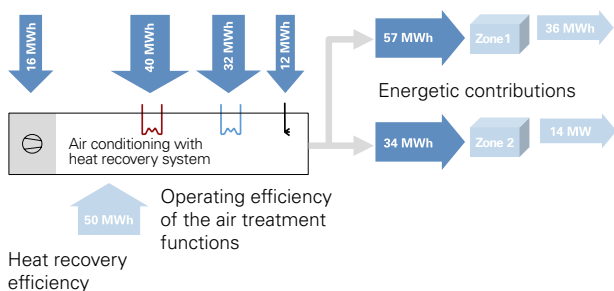

4. TANDEM SOLUTION WITH EXTERNAL FLOW REGULATION ("DAMPER MODULE") (optional)

MS LZ EZ

Individual rooms or complete zones are currently supplied with appropriate, demand-based volume flows using volume flow regulators. Luftmeister® complements and upgrades this system into a perfect "tandem" solution by providing highly accurate actual values and target values to the regulator (via Modbus-RTU or as fixed values). Luftmeister® not only monitors the damper position but also alerts the operator if the target and actual values do not converge quickly enough.

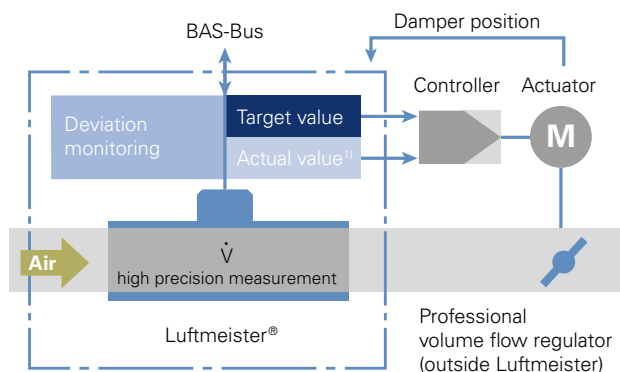

1) Transfer of density-corrected differential pressure (0 (2) ..10V) or of volume flow analog output



6. FILTER MONITORING (optional)

MS LZ EZ

In an air filter monitoring system, which is based on differential pressure, the current standard method of monitoring a fixed limit value (e.g. 200 Pa) is not effective if the volume flow is varied using a frequency converter (FC). Even if the filter is dirty, it is no longer possible to reach the fixed limit value.

Luftmeister® offers a practical solution: Luftmeister® calculates a function with a sliding limit value combining the connected filter differential pressure and the volume flow. An alarm is now triggered either via MODBUS or switching output when the true limit value is reached.

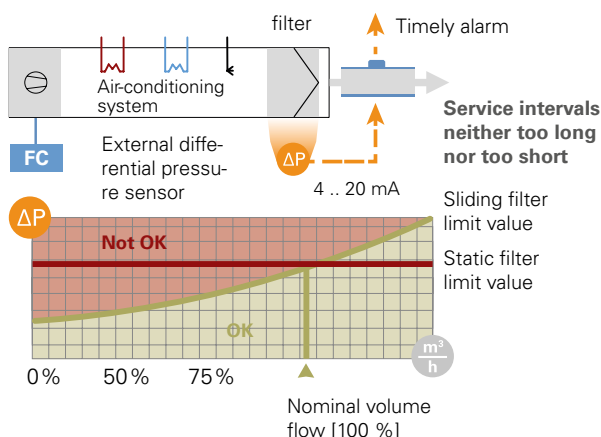

FUNCTIONALITY OF THE AIR ENERGY METER

EZ How does Luftmeister® EZ differentiate between supplies of heated and cooled air? After determining thermal capacity through mass flow and the enthalpy difference (Δh) between the balance limits, the energy contributions are calculated. Here, all the energy quantities in time periods with a positive enthalpy difference are assigned to a "red" heat supply account Q_p . If the enthalpy difference is negative, the energy quantities are assigned to a "blue" cold supply account Q_N .

Thermal capacity = $\text{Mass flow} \times \text{Enthalpy difference}$

$\frac{\text{kg}}{\text{h}} \times \left(\frac{\text{kWh}}{\text{kg}} \text{ minus } \frac{\text{kWh}}{\text{kg}} \right)$

Energy = thermal capacity over time

at $\Delta h > 0$: $\frac{\text{kWh}}{\text{kg}} (Q_p)$
 at $\Delta h < 0$: $\frac{\text{kWh}}{\text{kg}} (Q_N)$

The (specific) enthalpy describes the energy content per kg of air and is determined in the Luftmeister® EZ using temperature, humidity and absolute pressure sensors.

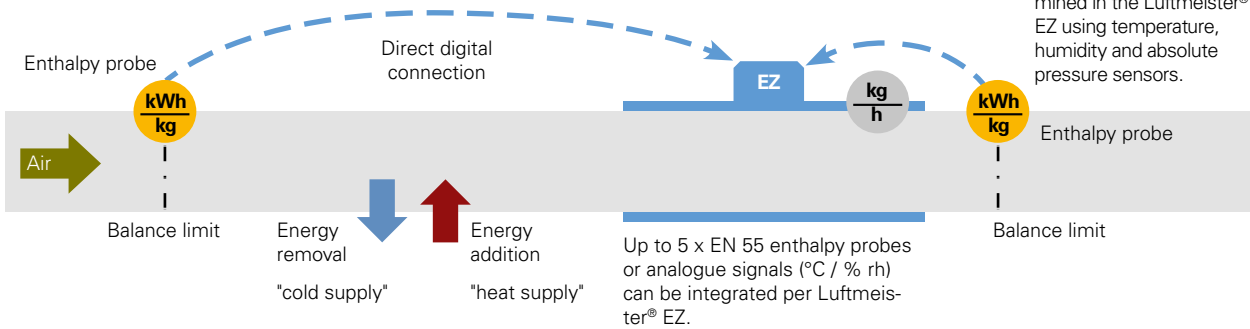

ENERGY CONTRIBUTIONS IN VENTILATION SYSTEMS

1 IDENTIFY EFFECTIVE ENERGY FLOWS

How much effective energy (separated into heating and cooling energy) flows into the individual zones of use via the supply air? This information is important both for understanding consumption costs and for energy management, e.g. in highlighting leakages, heat loss or ways to optimise regulation strategies. An example of a Luftmeister® measurement concept is shown in the graphic below. The equation in the example shows how Luftmeister® **B** analyses "zone 1".

2 CONTROLLING AIR TREATMENT

Each Luftmeister® EZ can be used with up to five enthalpy probes, further enthalpy values are available via the Luftmeister EZ bus (which connects all the energy meters)(1). For example, if a Luftmeister® is installed in a central air inflow duct (**A** in the graphic below) and an enthalpy measurement (here **1** .. **4**) is taken before / after each relevant stage of air treatment, you can see the thermal energy contribution of each of these stages (e.g. for warming) at any point in time. This makes inefficient control sequences visible, where e.g. cooling and HR deliver opposing energy contribution.

3 CONTROLLING HEAT RECOVERY (HR)

What contribution does heat recovery (HR) make in each phase of the operation? Is it delivering the forecast savings? Is it possible to identify further potential for making HR even more efficient?

If you compare this thermal energy with the energy input (e.g. using a heat energy meter on the water side), you can determine the system's level of efficiency. The result is a continuous energetic inspection. In addition, the responsible air treatment step of the AC unit can be addressed quickly in the case of undersupply.

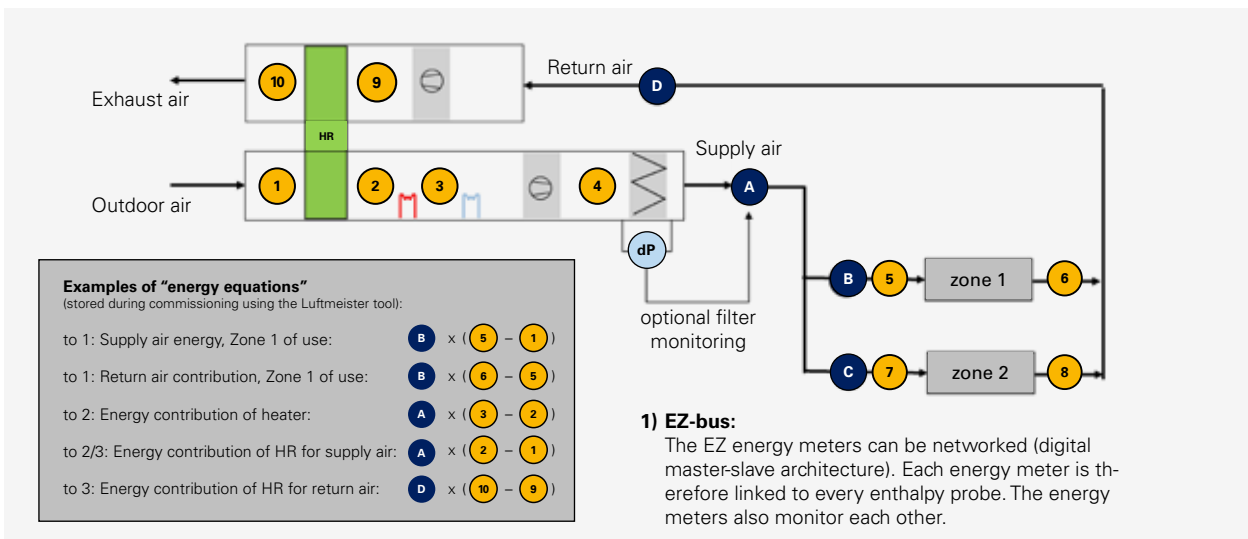

LEGAL-FOR-TRADE CALCULATION OF VENTILATION COSTS

The new German Guideline for Energy Consumption Accounting for Ventilation Costs (VDI 2077 Sheet 4) makes provisions for calculation of charges based on consumption. The Luftmeister® LZ and EZ cover every scenario: Luftmeister® continuously records all consumption data in a legally secure format. As well as an optional impulse or M-bus output (or MODBUS-RTU) for transmitting consumption data, Luftmeister® can be supplied with an easy-to-use optional display. Luftmeister® also offers access to past consumption data and momentary powers values (volume flow, temperature etc.). Generally, all consumption meters can also be read for long (monthly / annually) as well as short periods (up to ten minute intervals). Up to nine meter and current values for the past two years are stored on-board (5 minute interval).

COSTS PER ZONE ACCORDING TO AIR CONSUMPTION

LZ **EZ** see p. 8 for order codes

Every zone of use is charged for its share of the costs (total input costs) based on its share of air consumption (V).

● Luftmeister® LZ or EZ

Input costs (€)

Outdoor air → Air-conditioning system → Supply air

Zone 1 (V₁)
Zone 2 (V₂)

[V] = m³ or kg
(total air consumption)

Costs (zone i) =
$$\text{Input costs} \cdot \frac{V_i}{\sum_i V_i}$$

... ACCORDING TO AIR CONSUMPTION, WARM AND COLD SUPPLY

EZ Every zone of use is charged for its share of electricity and water costs based on its share of air consumption (V), while heated and cooled air supplied via the supply air are charged based on the zone's shares of the warm air meter (Q_p) and cold air meter (Q_N).

EZ

Every zone of use is charged for its share of electricity and water costs based on its share of air consumption (V), while heated and cooled air supplied via the supply air are charged based on the zone's shares of the warm air meter (Q_p) and cold air meter (Q_N).

● Luftmeister® EZ, ● Enthalpy probe EN

Input costs (€)

Outdoor air → Air-conditioning system → Supply air

Zone 1 (V₁, Q_{p1}, Q_{N1})
Zone 2 (V₂, Q_{p2}, Q_{N2})

[V] = m³ or kg
(total air consumption)

[Q_N] = kWh
(heated air supply)

[Q_p] = kWh
(cooled air supply)

Luftmeister® EZ has 3 meters, see p. 6 above

Costs (zone i) =
$$\text{Input costs (electricity, water)} \cdot \frac{V_i}{\sum_i V_i} + \text{Input costs (heat)} \cdot \frac{Q_{p_i}}{\sum_i Q_{p_i}} + \text{Input costs (cold)} \cdot \frac{Q_{N_i}}{\sum_i Q_{N_i}}$$

LUFTMEISTER TOOL: PARAMETERISATION, ANALYSIS

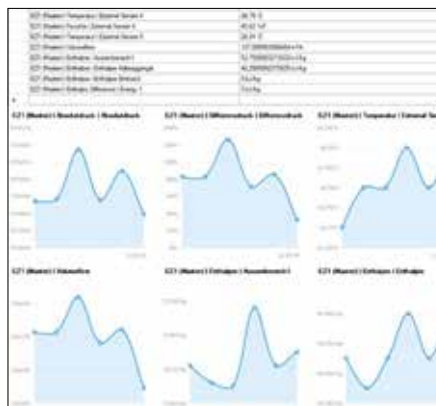
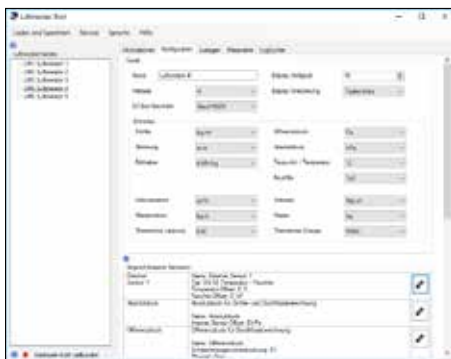

The professional PC software "Luftmeister Tool" can be used for commissioning as well as servicing and operation. This parameterises all inputs and outputs, reads out logger values to Excel in the CSV exchange format and displays the error, meter, and adjustment logbooks.

ORDER OPTIONS

Order code	A	B	C	D	E	F	G	H	J	K	L
Luftmeister®											

Typ	A	
MS	Mass flow compact 55 ¹⁾	MS 55
	Mass flow remote 57 ¹⁾	MS 57
LZ	Air meter compact 55 ¹⁾	LZ 55
	Air meter remote 57 ¹⁾	LZ 57
EZ	Energy meter compact 55 ¹⁾	EZ 55
	Energy meter remote 57 ¹⁾	EZ 57

Display ²⁾	C
None	0
with	1

2) Obligatory, if L = 1

Analogue inputs/ Enthalpy probe ³⁾	D
Enthalpy probe inputs ³⁾ / Analogue inputs ⁴⁾	0..5 ⁵⁾

3) Please order the appropriate EN 55 enthalpy probes separately

4) Inputs 4..20 mA: °C, %rh, Pa(abs), Pa (differential pressure for external flow sensor system (J=0)). Note: EN 57 is evaluated as 2 analogue inputs, EN 55 as one.

5) For MS or LZ: 0 – 4 for EZ: 0..5

Outputs (1)	E
5 analogue outputs	AN
5 switch/impulse	SI
Filter monitoring/ Damper module ⁷⁽⁸⁾	FK

Outputs (2)	F
Modbus-RTU	RTU
M-Bus ⁶⁾	MTB
5 analogue outputs	AN
5 switch/impulse	SI
Filter monitoring/ Damper module ⁷⁽⁸⁾	FK

Outputs (3)	G
Modbus-RTU	RTU
M-Bus ⁶⁾	MTB
5 switch/impulse	SI
Filter monitoring/ Damper module ⁷⁽⁸⁾	FK

6) M-Bus – for LZ / EZ only
7) Filter monitoring and flow regulation are alternatively available
Details see p. 5 section 4 and 6
8) Damper module = actual/target values for external flow regulation

Ethernet-Bus	H
BACnet / IP ⁹⁾	BN
None	0

9) in preparation

Pressure sensors ¹⁰⁾	J
Internal (standard equipment)	P
Without (for external differential pressure sensors, only with xx 57) ¹⁰⁾	0

10) Without internal pressure sensor system if external differential pressure transmitters are to be connected, e.g. for EX areas etc.

Calibration	K
Without laboratory adjustment	0
With laboratory adjustment ¹¹⁾	1
With ISO certificate ¹¹⁾	2
With DAKKS certificate ¹¹⁾	3

11) only for xx 55

Legal-for-trade calibration ¹²⁾	L
None	0
with (in preparation)	1

12) For LZ 55 und EZ 55 only

1) The 55 and 57 series are explained on page 3

Dimensions [mm] B	
Round / plug nipple DN 100 to DN 630	e.g. C315S
Round / Flange DN 100 to DN 630	e.g. C500F
Rectangular / Flange 200x100 to 1000x1000	e.g. 300x200

Virtually any cross-section dimensions are possible with Type xx57: Select option "B" = 0. Primary elements are sold separately

SAMPLE ORDERS

1. Example: Air energy meter with 2 enthalpy probes

(e.g. C on p. 6 below, 1, 7 are connected)

Order code Luftmeister® air energy meter for conditioned air:

EZ 55 / C315F / 0 / 2 / FK / MTB / RTU / 0 / P / 0 / 0

(compact solution, air duct diameter 315 mm, round with flange, without display, 2 EN connections, filter/damper module, M-bus, Modbus RTU, internal ΔP sensor, no laboratory adjustment)

Order code for enthalpy probe: 2 x EN55-1 (incl. display)

2. Example: Air meter for high temperatures (> 60 °C)

Order code Luftmeister® air meter for conditioned and process air:

EZ 57 / 0 / 1 / 2 / AN / RTU / FK / 0 / P / 0 / 0

(remote solution, primary elements to be ordered separately, display, 2 analogue connections (for EN 57), 5 analogue outputs, Modbus, filter monitoring module, internal ΔP sensor, no laboratory adjustment)

Order code for enthalpy probe: 1 x EN57

We will be pleased to supply a suitable primary element as well as on-site calibration and start-up for your measurement location.

ENTHALPY PROBE

AC enthalpy probe 55



for standard conditioned air
-20 .. 60 °C

Accuracy EN55

Relative humidity
(-15 .. 40 °C, 0 .. 90 % rh):
± 1,3 .. ± 1,57 % rh

Temperature:
± 0,2 °C ± 0,0067
* (measured value - 20 K)

Order code: EN55-1 with display
EN55-0 without display

Process enthalpy probe EN 57



also for contaminated air / heated humidity sensor -40 .. 180 °C¹²⁾

Accuracy EN57

Relative humidity
± (1,0 .. ± 0,007 x Mw) % rh
± 0,02 %rh pro K deviation
from 25°C

Temperature:
± 0,15 °C ± 0,0017
* (measured value - 25 K)

Order code: EN 57, please inquire

¹²⁾ at temperatures < - 40 and >180 °C or pre-defined fixed values for humidity:
Use of temperature transmitters (via Luftmeister® analogue input)

TECHNICAL DATA (SEE ALSO P. 3)

Measuring accuracy Mass flow	± 3 % v. M. at 10 m/s ± 7,5 % v. M. at 1 m/s	Medium	55 series, EN 55: Uncontaminated air, 1 .. 10 m/s 57 series / EN 57: Conditioned and process air 1 .. 25 m / s (dependent on primary element)
Measuring accuracy of static absolute pressure	± 3 hPa		
Installation for Luftmeister® xx55	Round air ducts: connectors with plug nipple, rubber lip seal or flanges Rectangular air ducts: with screw flanges	Multi-channel data logging (MS, LZ, EZ) and recording of meter readings (LZ, EZ)	Refresh rate: every 2 seconds Storage frequency: 1, 2, 3, 5, 10, 15, 20, 30 min 1, 2, 4, 6, 8, 12, 24 h Available values: consumption for the past 24 months + (at storage frequency of 5 min) logger data for the past 2 years
Power supply	90 .. 240 VAC, 50 .. 60 Hz, 80 W Pmax Protection Class 2 with Functional Earth	Certificates	CE, legal-to-trade in prep. ¹³⁾

13) for LZ / EZ 55 only